

Talko 2 assembly manual

Introduction

Nothing complicated here, but **the PCB is designed for both Eurorack/Terminal and the bricky-sized versions!**

The assembly guide for the Talko Terminal is here : [Talko 2 Terminal assembly manual](#)

⚠ **Warning:** Make sure to read this first!

- Ensure the LED display is oriented correctly, check the dot indicator, and appropriately placed (Eurorack/Terminal vs bricky). (There are 4 positions possible, but only one is correct !)
- Correctly position the yellow and blue push buttons and choose the correct orientation. (Eurorack/Terminal vs bricky).
- Make sure the op amp is oriented correctly.
- IC2 and T1 look identical, so double-check their markings before soldering.

Tools

All required components are provided in the kit.

You will also need a soldering iron, solder, a wire cutter, and some tape. A desoldering pump may also be helpful ;-).

Take your time, read each step carefully, and follow the sequence as presented.

After completing the assembly, you may **need to flash the firmware** using a computer and a USB-C cable (make sure the cable **supports data**, not just power), which is not included in the kit.

Firmware

As of 2025-11-26, I have decided to ship Talko with the firmware installed.

You can verify whether it is installed by simply connecting the Pico to a USB power source: the LED at the back should flash to display the firmware version. Red indicates the major version, the blue dot is a separator, and green shows the minor version.

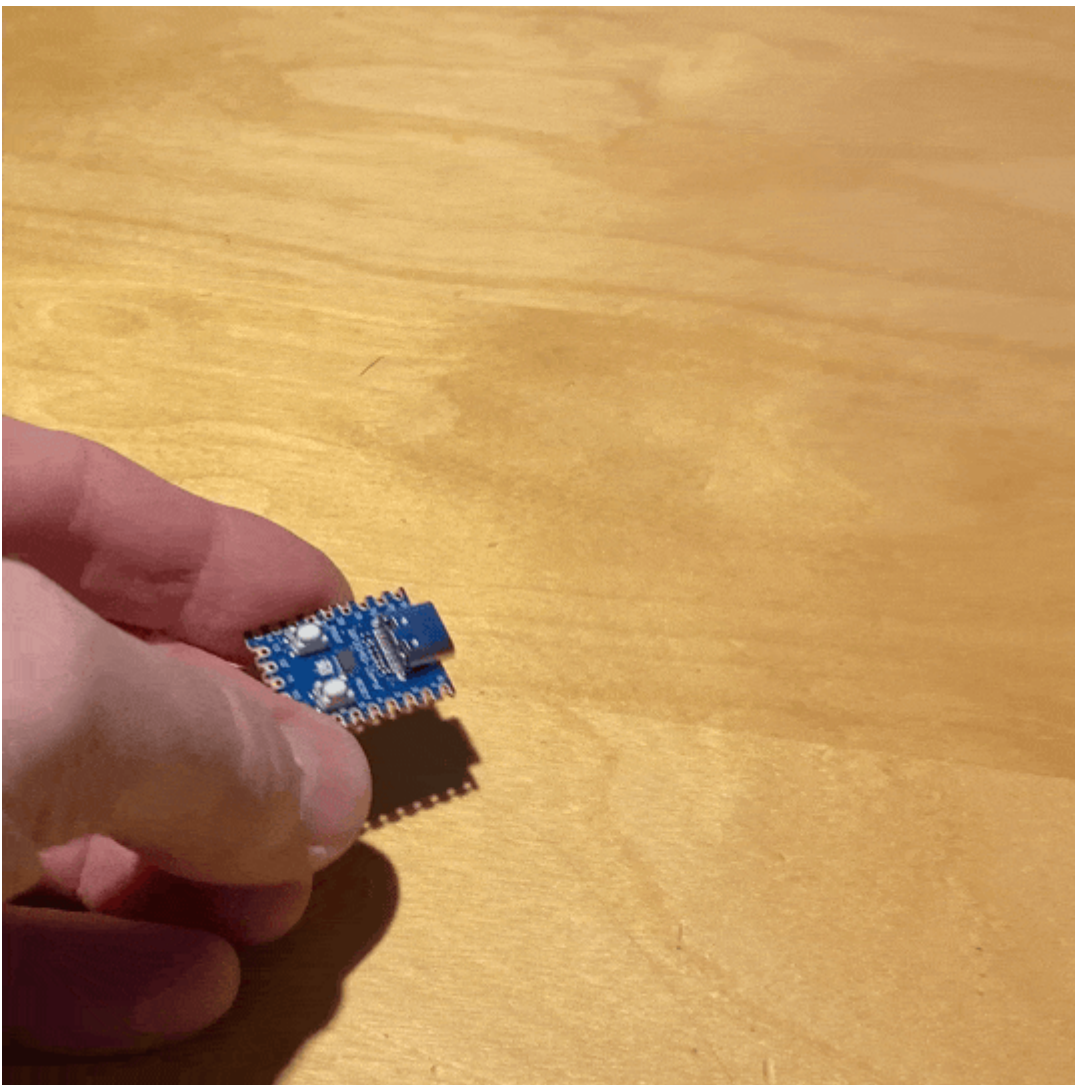

if you want to start flashing your Talko, you can do it now: check the procedure at the end of this page ...

Any questions ? please get in touch via [Discord..](#)

Bill of Materials (PCB 2.0a)

Qty	Value	Parts	Detailed Description
1		for Eurorack	10 PIN HEADER
1		J1 for Stand alone	DC Power Jack
9	0.1uF	C3, C5, C6, C7, C9, C10, C11, C12, C13	0.1μF ceramic capacitors
3	100K	R7, R8, R9	RESISTOR
4	10K	BEND_POT, PITCH_POT, SOUND_POT, SPEED_POT	10K Pot
3	10K	R19, R13, R14	RESISTOR
5	10uF	C1, C2, C4, C14, C8	10.0μF polarized capacitors
9	BAT85	D1, D2, D3, D4, D5, D6, D7, D8, D9	SCHOTTKY diode
1	2N3904	T1	NPN TRANSISTOR
4	3.3K	R16, R18, R21, R23	RESISTOR
10	330R	R1, R2, R3, R4, R5, R10, R11, R12, R24, R25	RESISTOR
5	47K	R15, R17, R20, R22, R6	RESISTOR
1	7-SEG_SA52-11	LED DISPLAY	NUMERIC DISPLAY
1	BEND	MODE	TINY SWITCH ON – ON
1	EC12E_SW	SW1	Rotary Encoder
6	J1	AUDIO, GATE, SOUND, PITCH, SPEED, FX	Thonkiconn jack
1	MCP1702-5002E_T0	IC2	IC, V REG, LDO, 250MA
1	MCP601P	IC1	Single Op Amp
2	PB86_STEPSWITCH	GATE, ERROR	PB86 Switch

Qty	Value	Parts	Detailed Description
1	RP2040	U1	RP2040

Soldering

Start by soldering the 9 BAT85 diodes D1, D2, D3, D4, D5, D6, D7, D8, D9

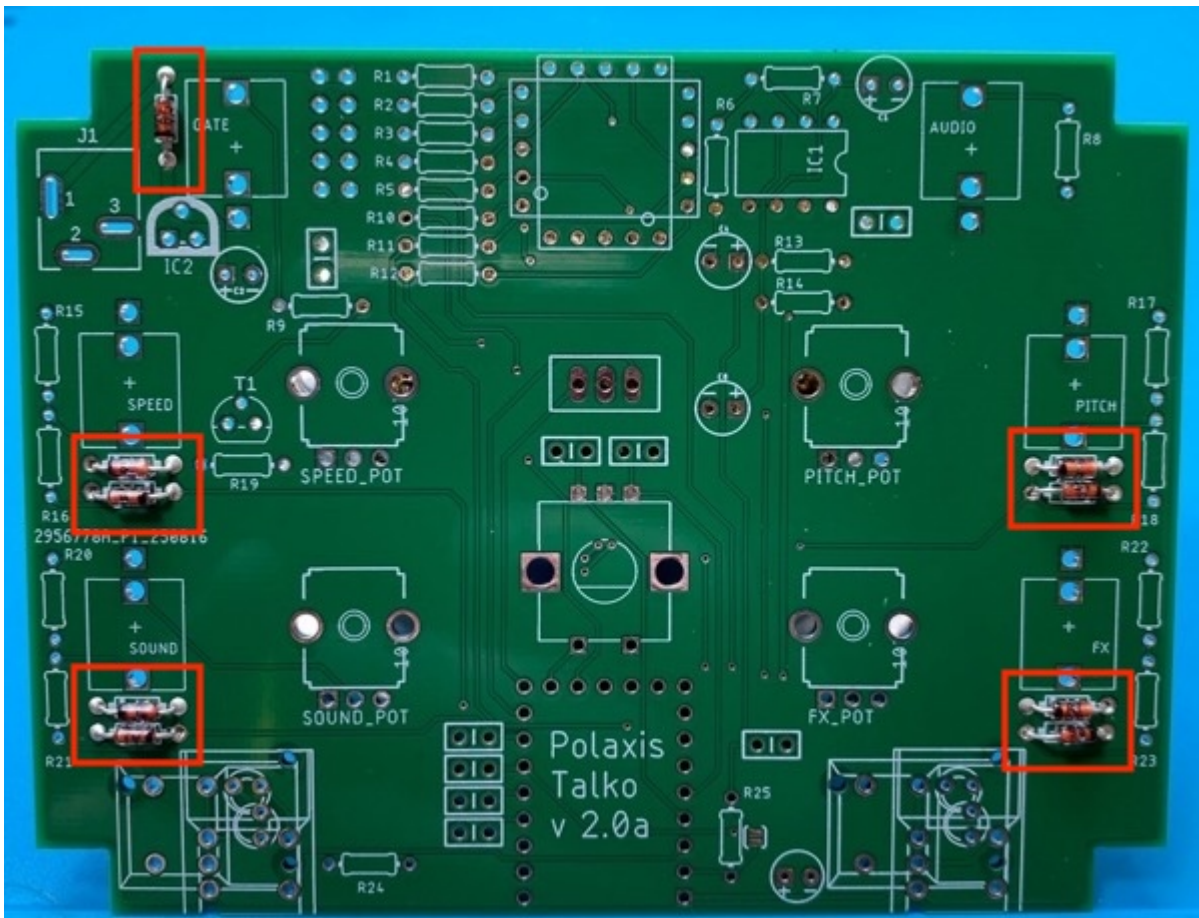

Then add the 3 100K resistors R7, R8, R9

100k ±1%



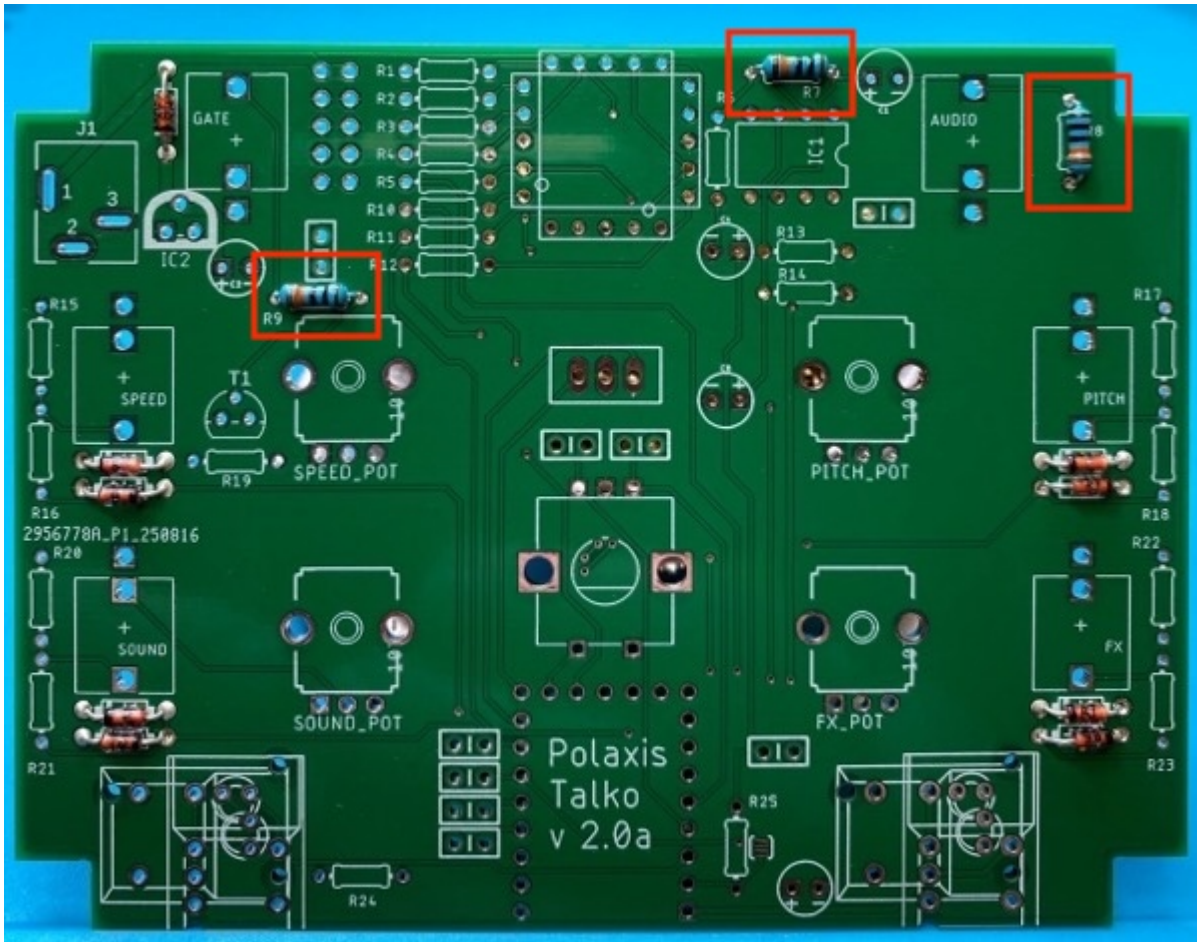

Then add the 3 10K resistors R19, R13, R14

10k \pm 1%



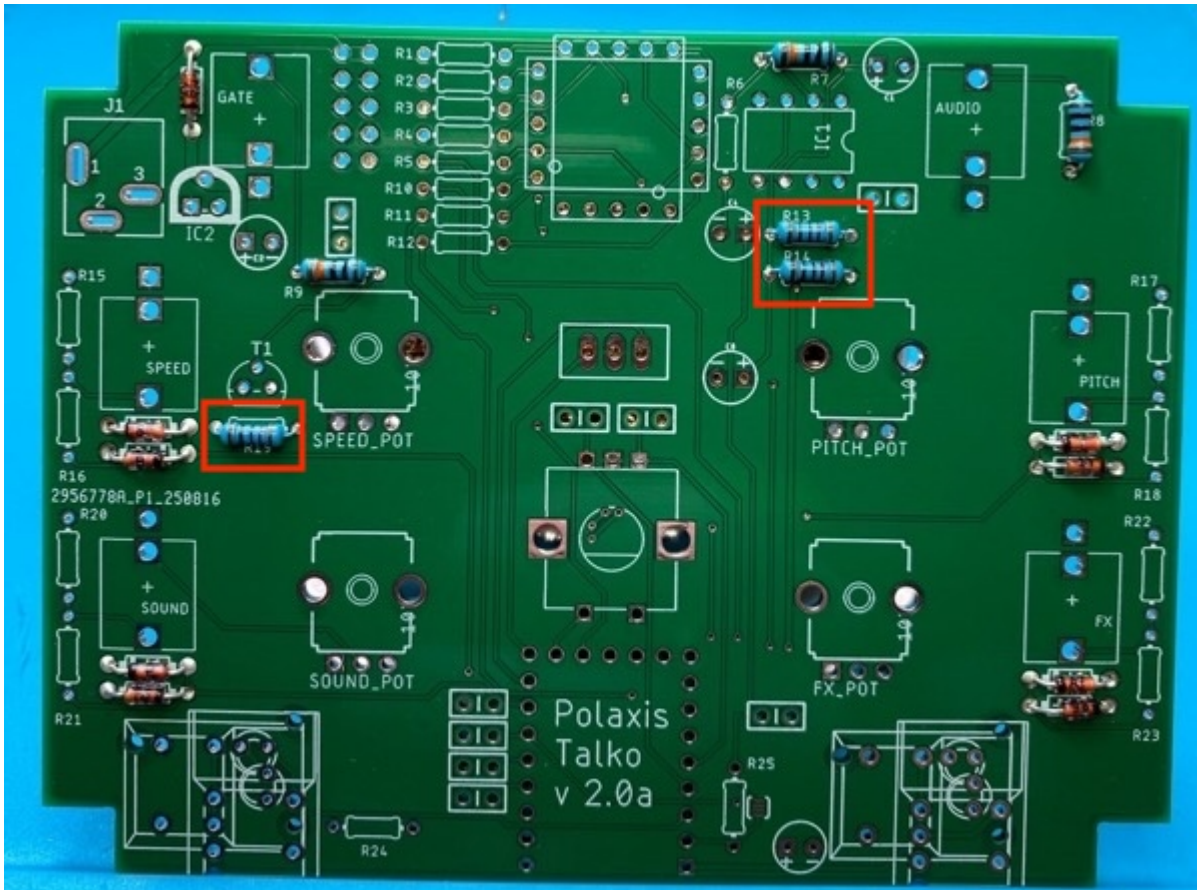

Then add the 4 3.3K resistors R16, R18, R21, R23

3.3k $\pm 1\%$



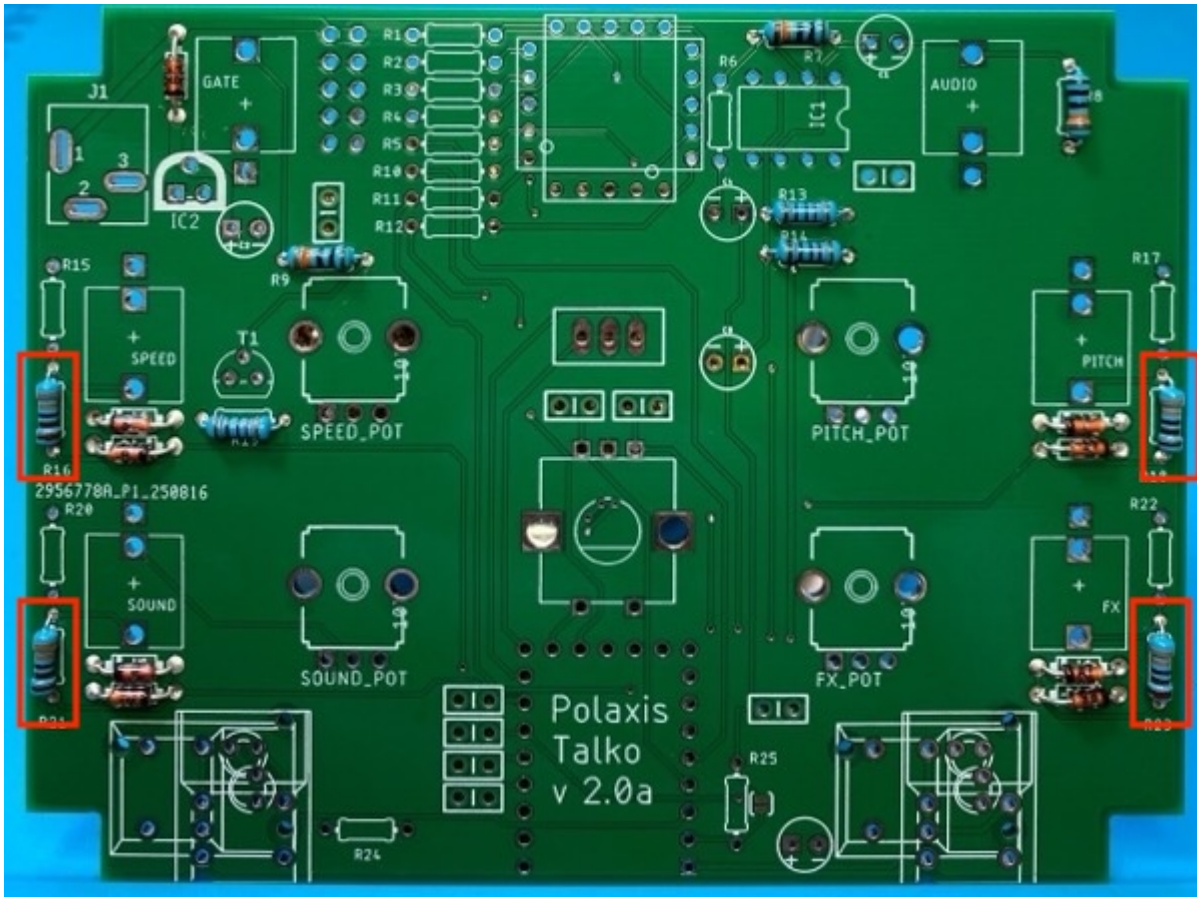

Then add the 5 47K resistors R15, R17, R20, R22, R6

47k $\pm 1\%$



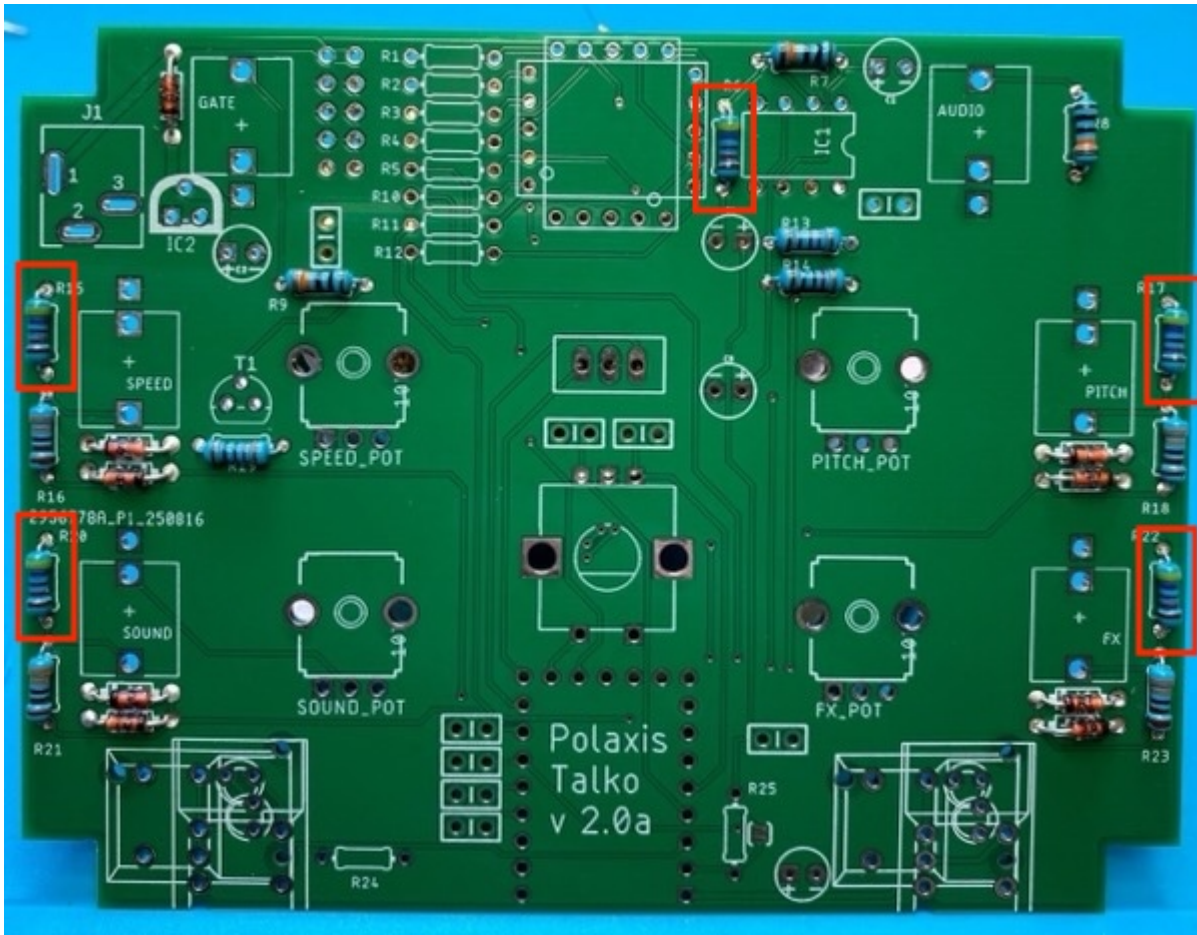

Then add the **10** 330R resistors R1, R2, R3, R4, R5, R10, R11, R12, R24, R25

330R $\pm 1\%$



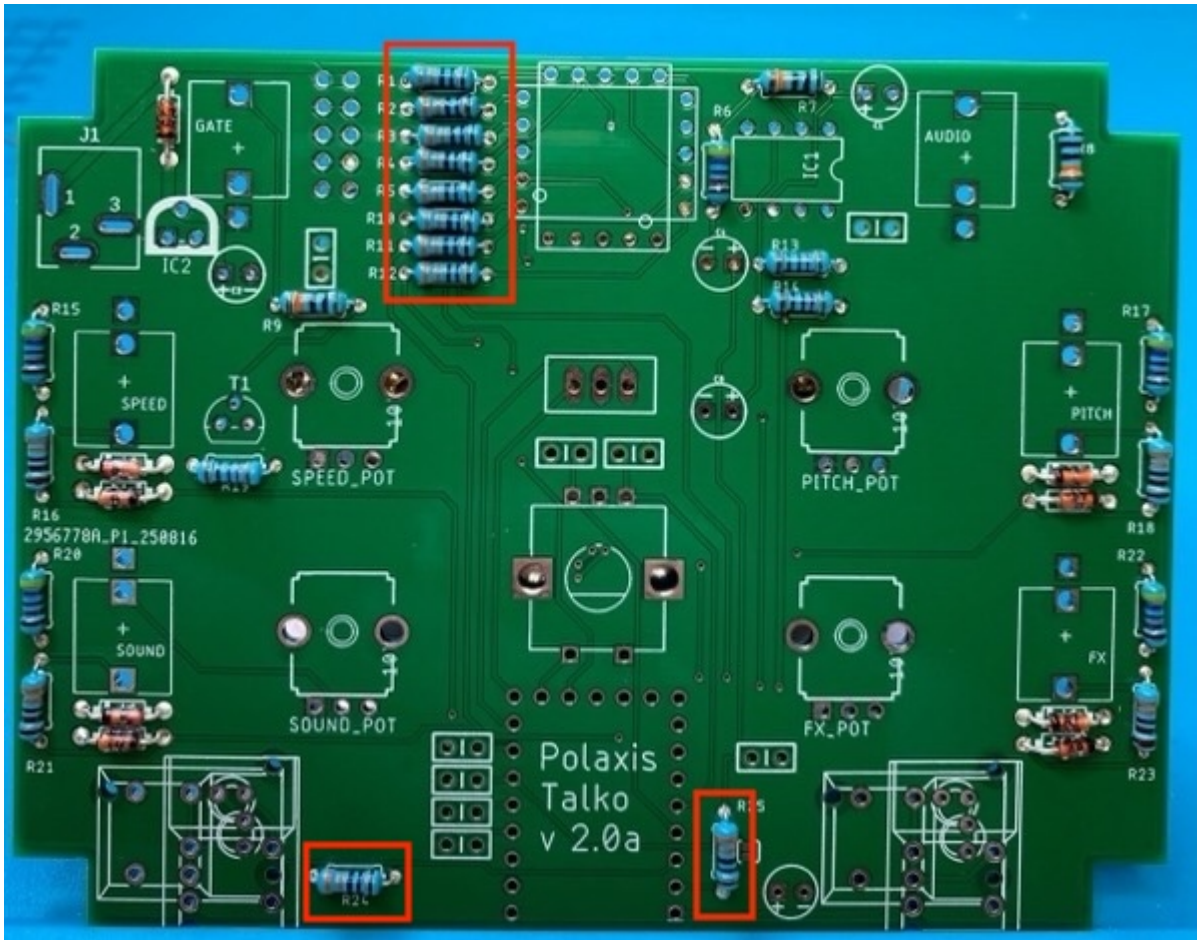

Now add the (9) 7 0.1uF capacitors C3, C5, C6, C7, C9, C10, C11, C12, and C13.

There are no IDs for these; just check this footprint.



Update : C6, C7 (rotary encoder caps): DNP
 → Do not place. New firmware handles debounce in software;
 hardware caps can make some encoders feel jumpy.

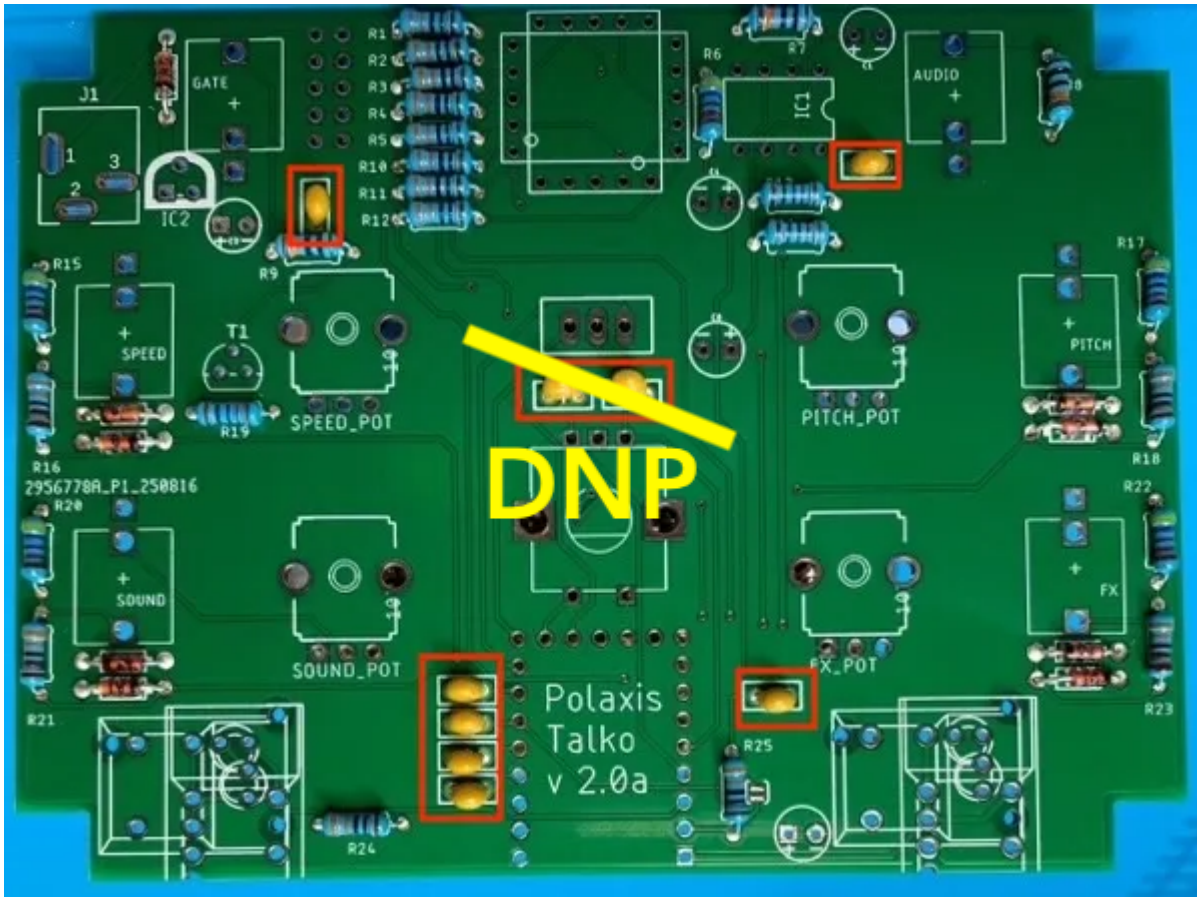

Add the op amp MCP601P

!!! Make sure to orient the chip with the notch.

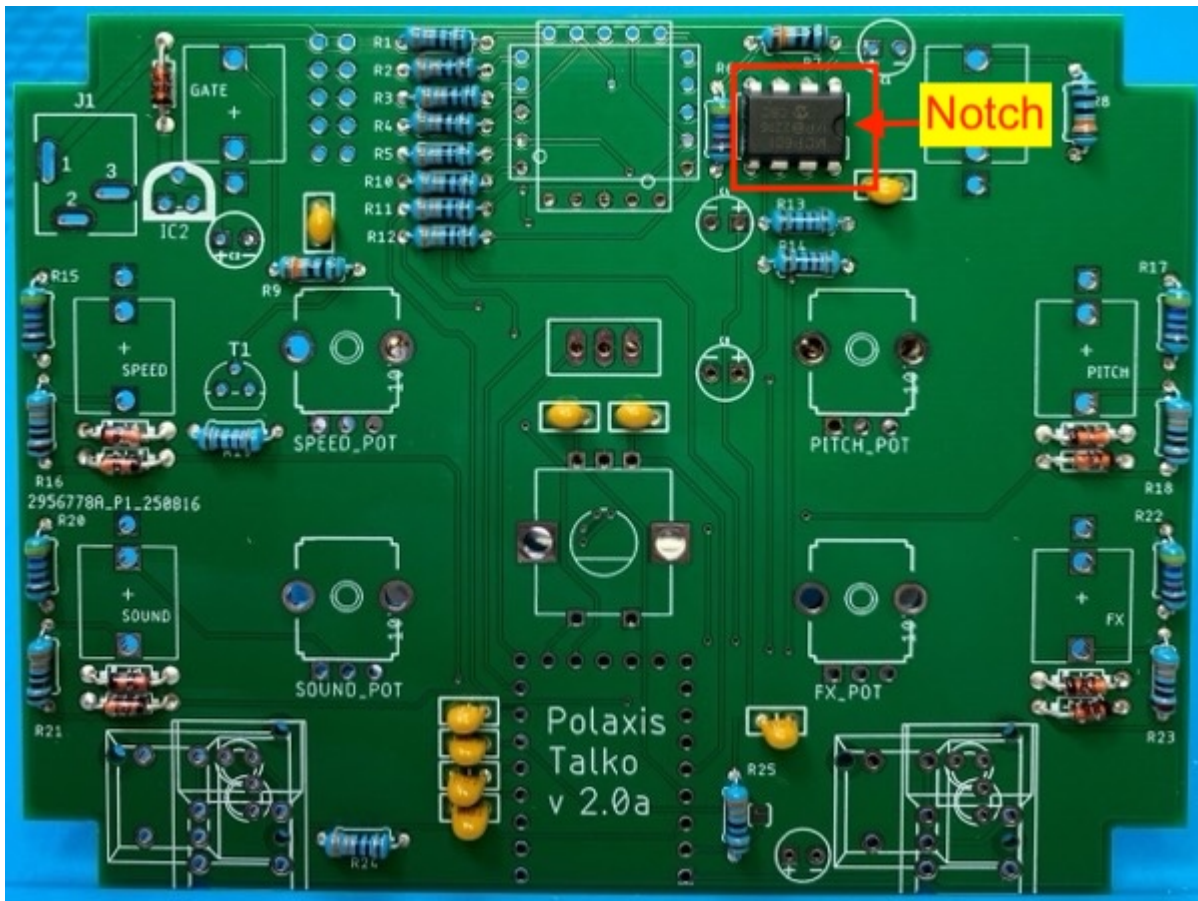

Add IC2 MCP1702 and T1 2N3904 (you must **read their respective labels**)

!!☐ These two share the same T0-92 package !

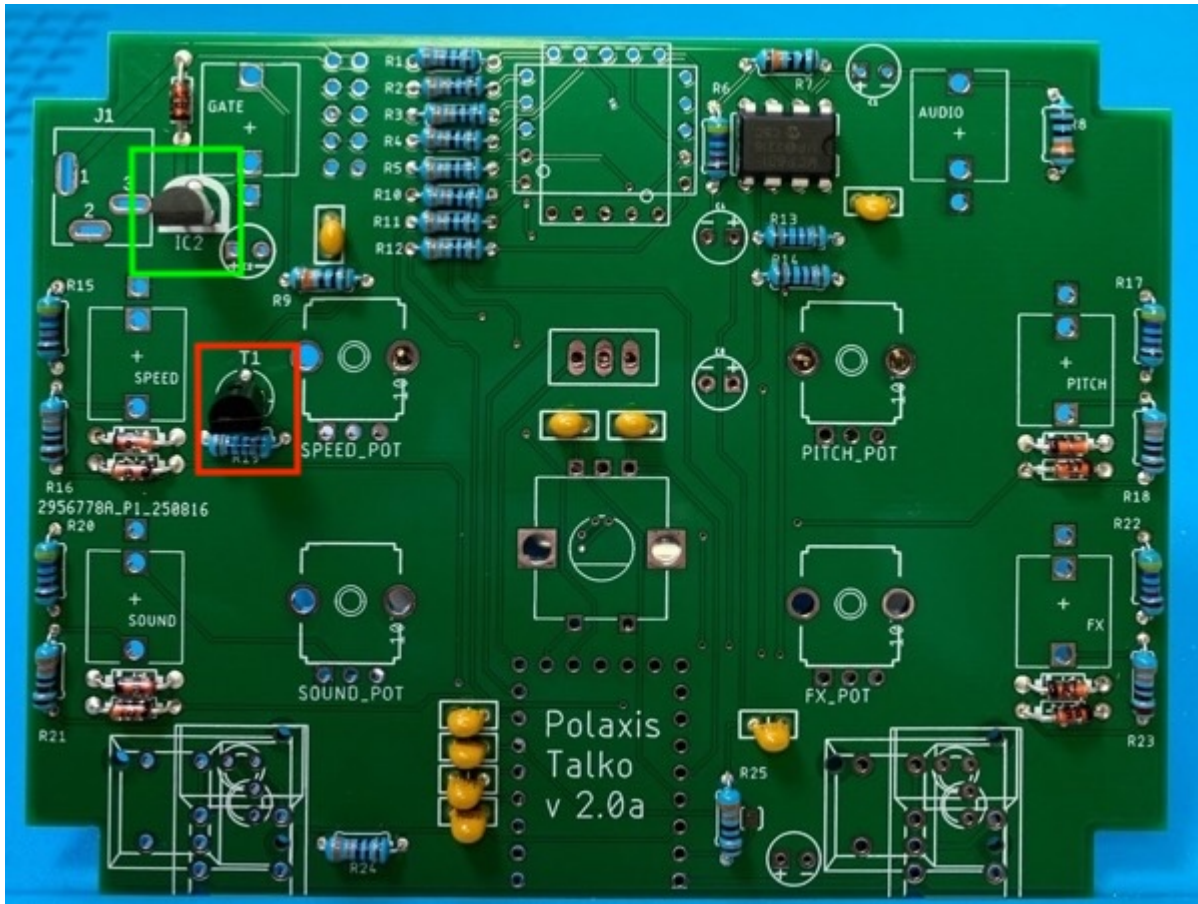

Ok now, let's add the 5 10uF electrolytic capacitors C1, C2, C4, C14, C8

They are pretty hard to remove from the paper reel, so I prefer to cut their legs to get them off the reel!

Please pay attention to their polarity (the minus is also the shortest leg).

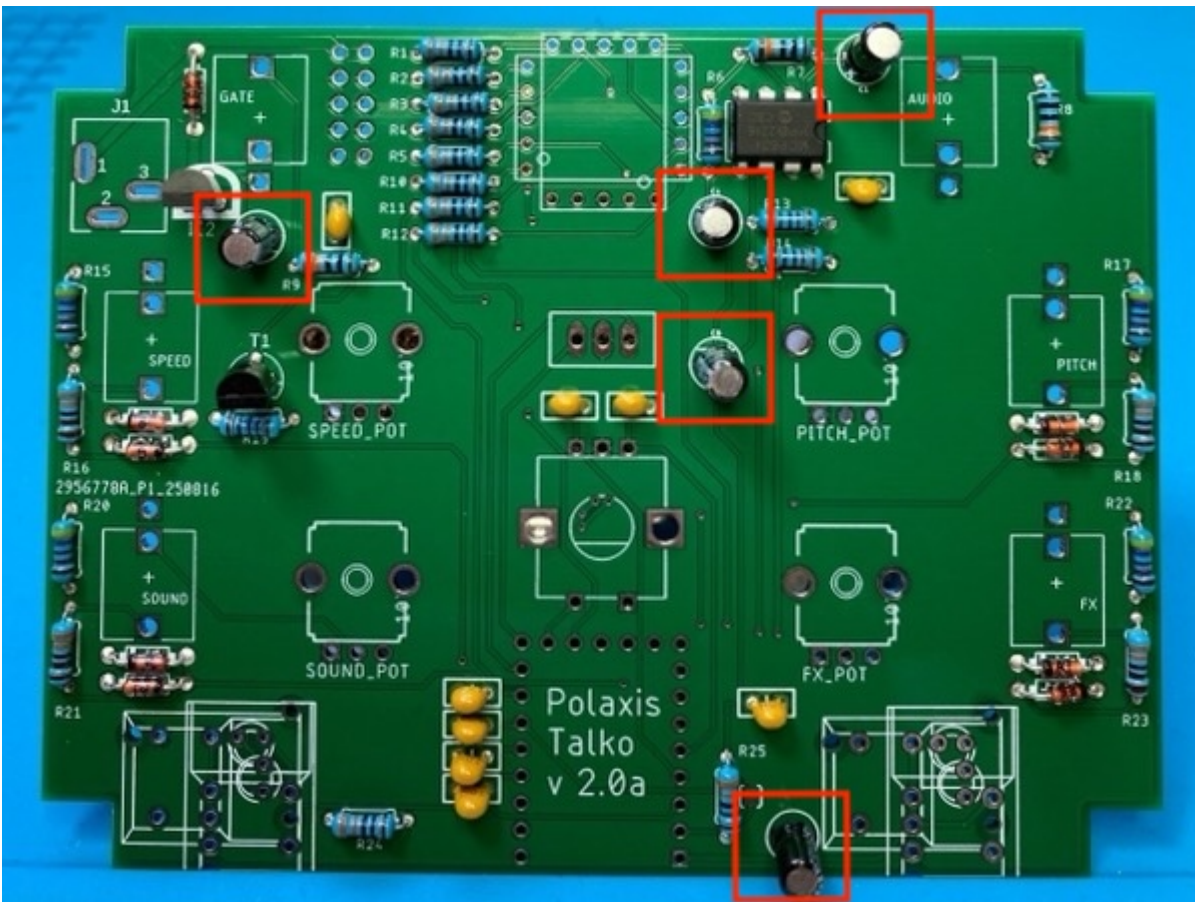
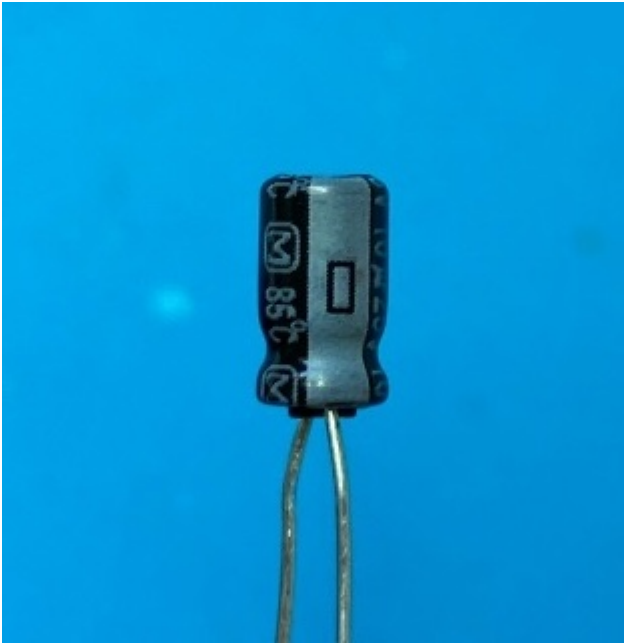

Okay, let's add the 4 pots, the switch, the encoder, and the 6 jacks. Don't solder yet! Secure everything in place with a rubber band before soldering.



□ Note : The jack, the rotary and the 3 positions switch need to be pushed towards to the PCB while soldering.
Add the DC connector, then proceed with soldering.



Let's place the 7-segment display, but don't solder it yet. Don't forget to peel off its protective film.

!!□ Ensure the display is oriented with the dot in the bottom right corner. Note that the PCB is designed for both Eurorack and Bricky formats; choose the right spot.

Here is how to place the display on the Bricky version

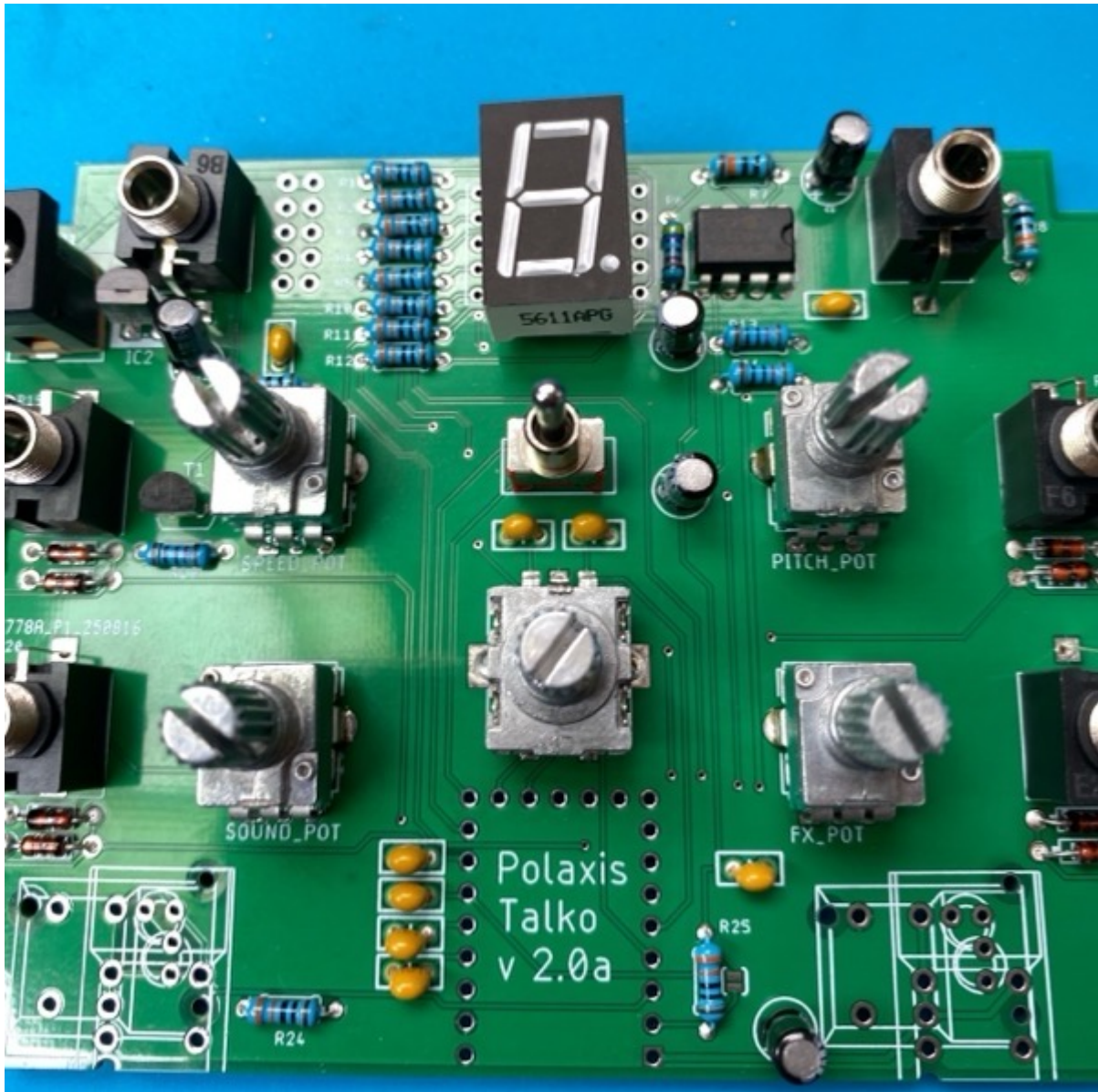

If you are assembling the Eurorack version, please ensure the display is oriented correctly.

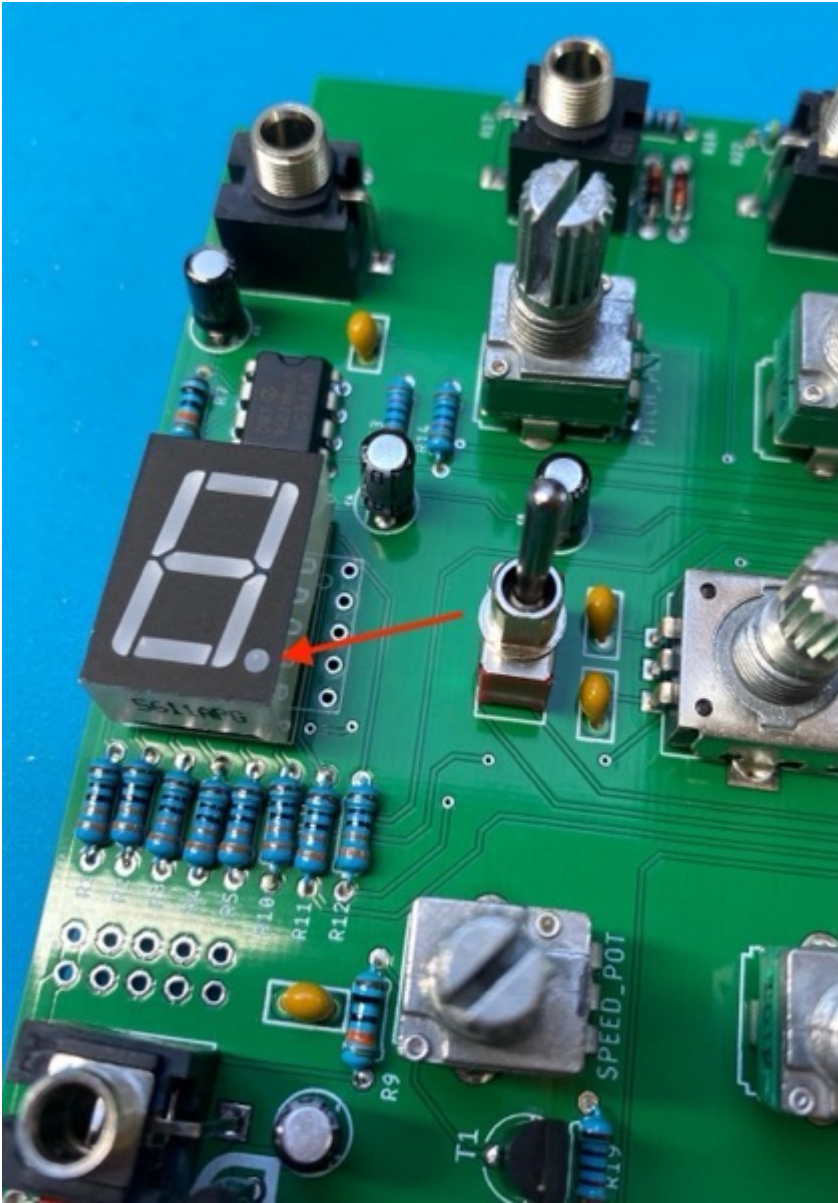

Place the panel back and use some tape to align the display flush with the panel.
When ready, solder the display.



Here the Eurorack version :



□ The Pico will be placed on the back of the PCB !
Insert the yellow headers on the back of the PCB.

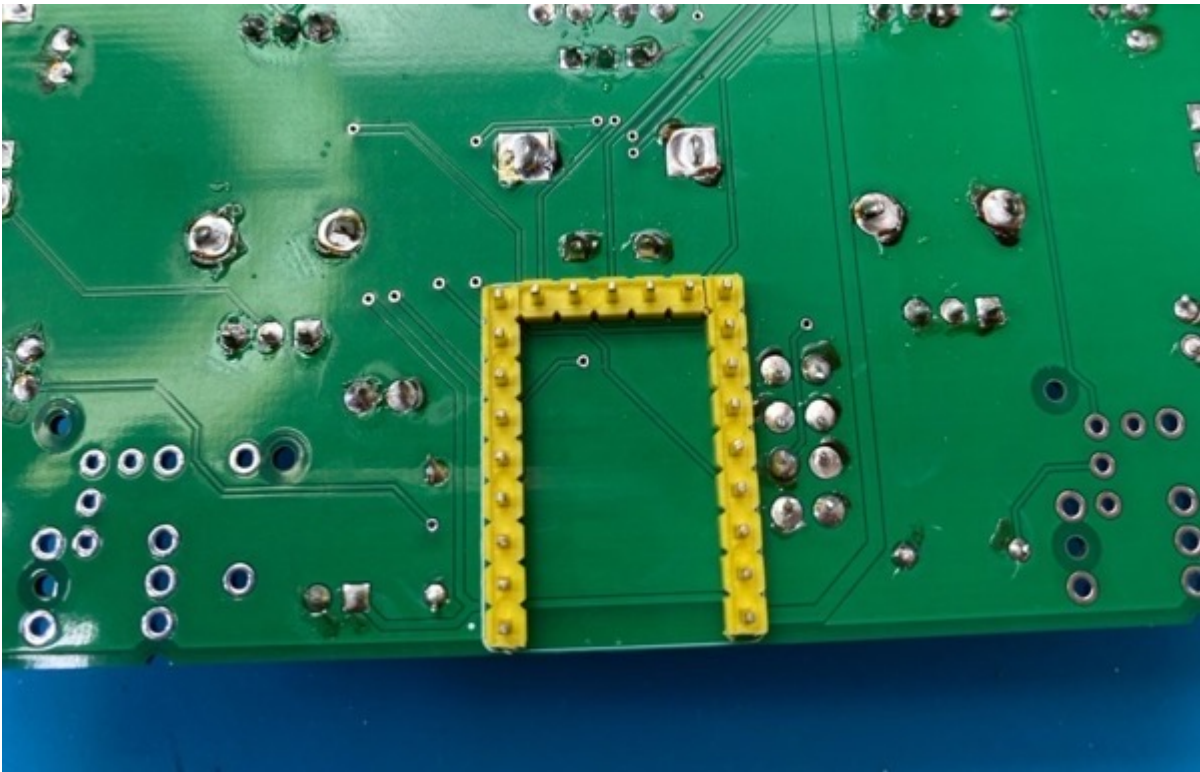

Solder just one pin on each header

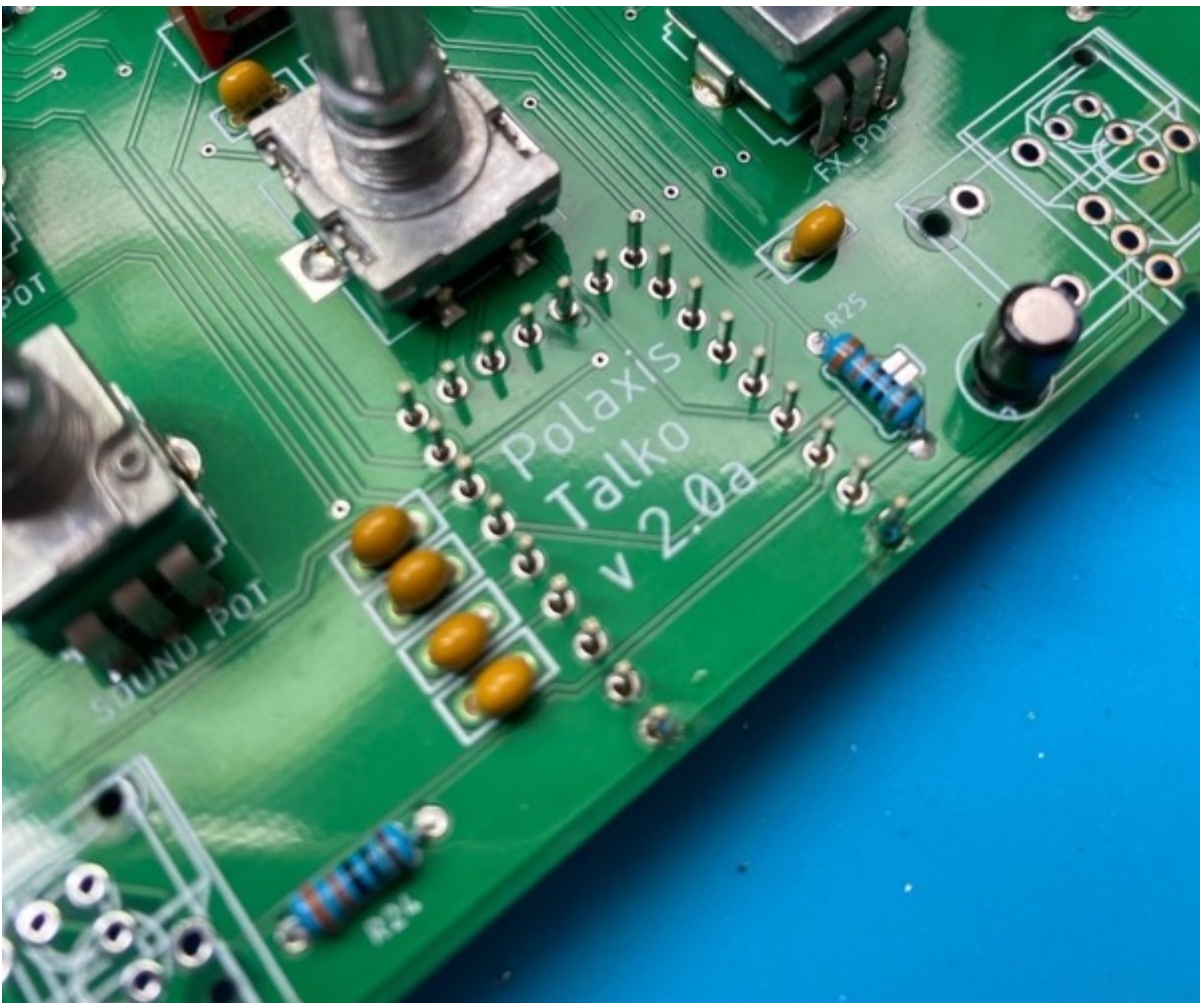

Add the RP2040 and solder the pins

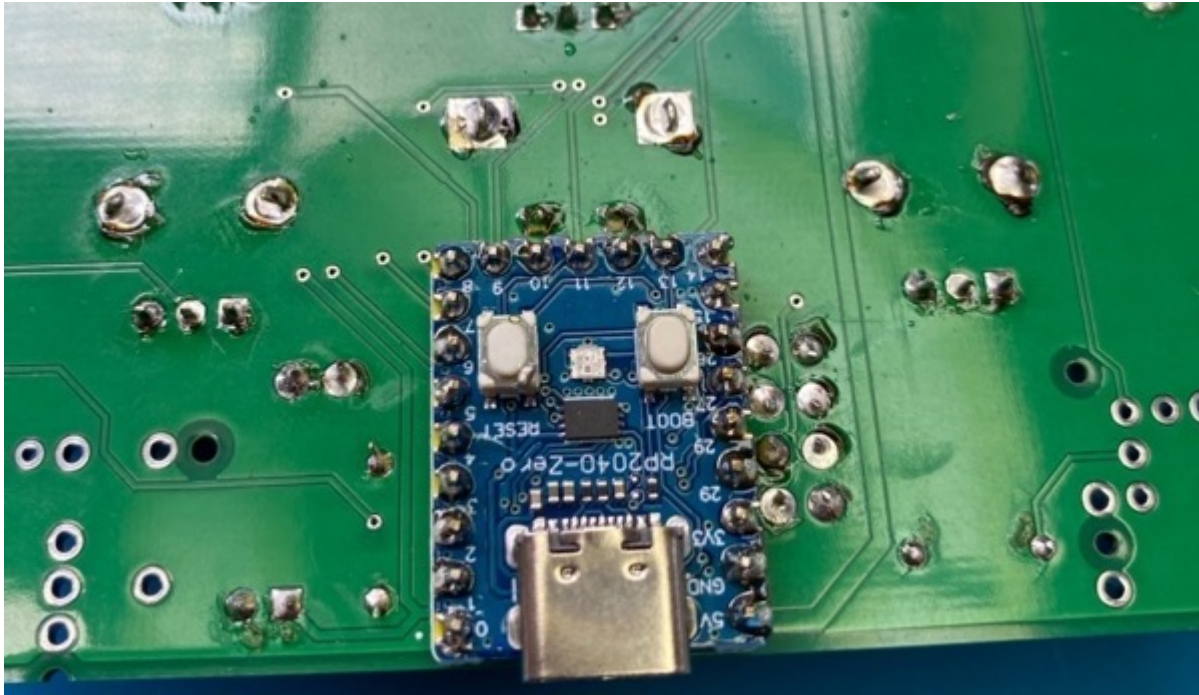

Go back to the component side and solder the headers.

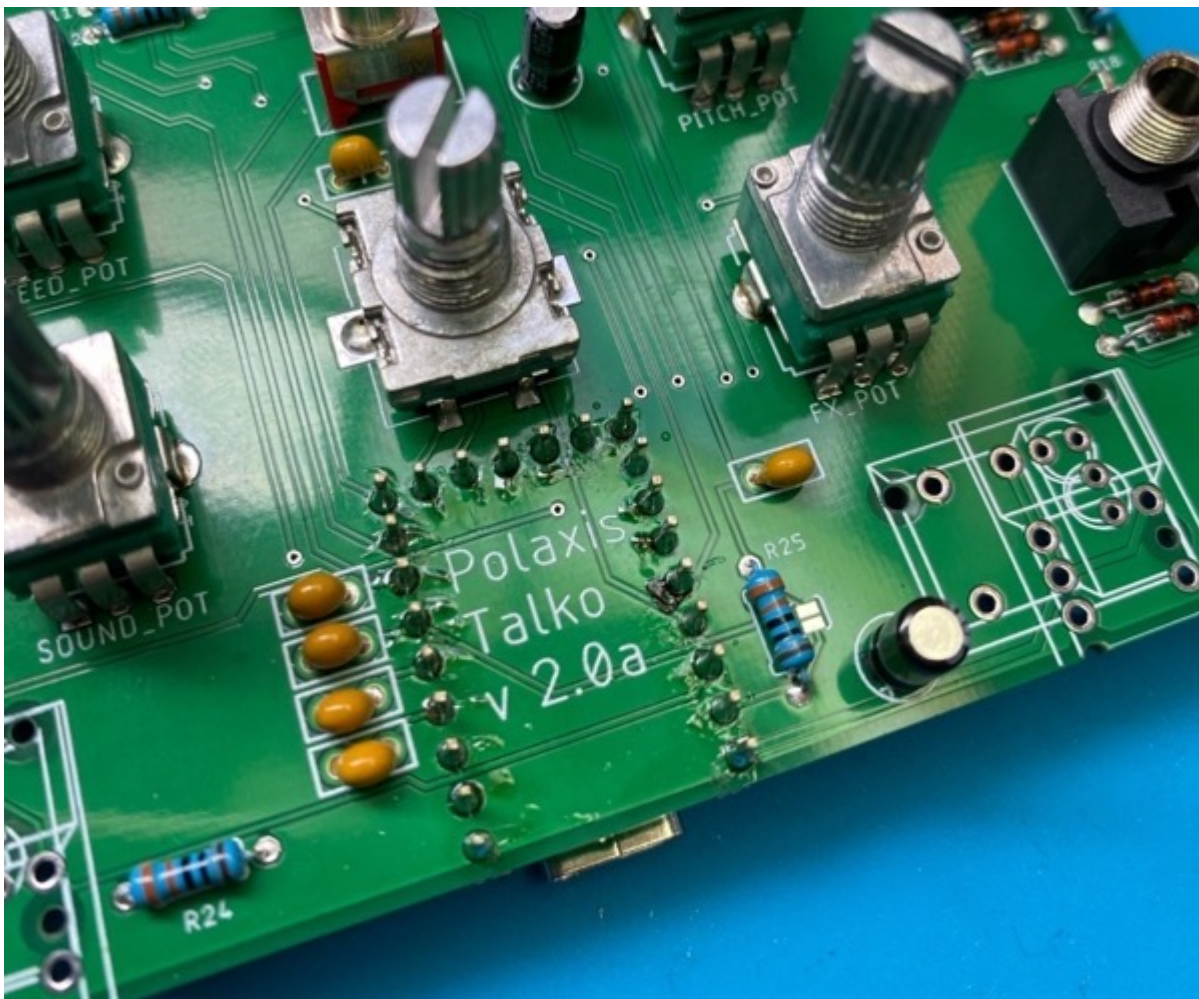

On Eurorack : time to solder the power connector

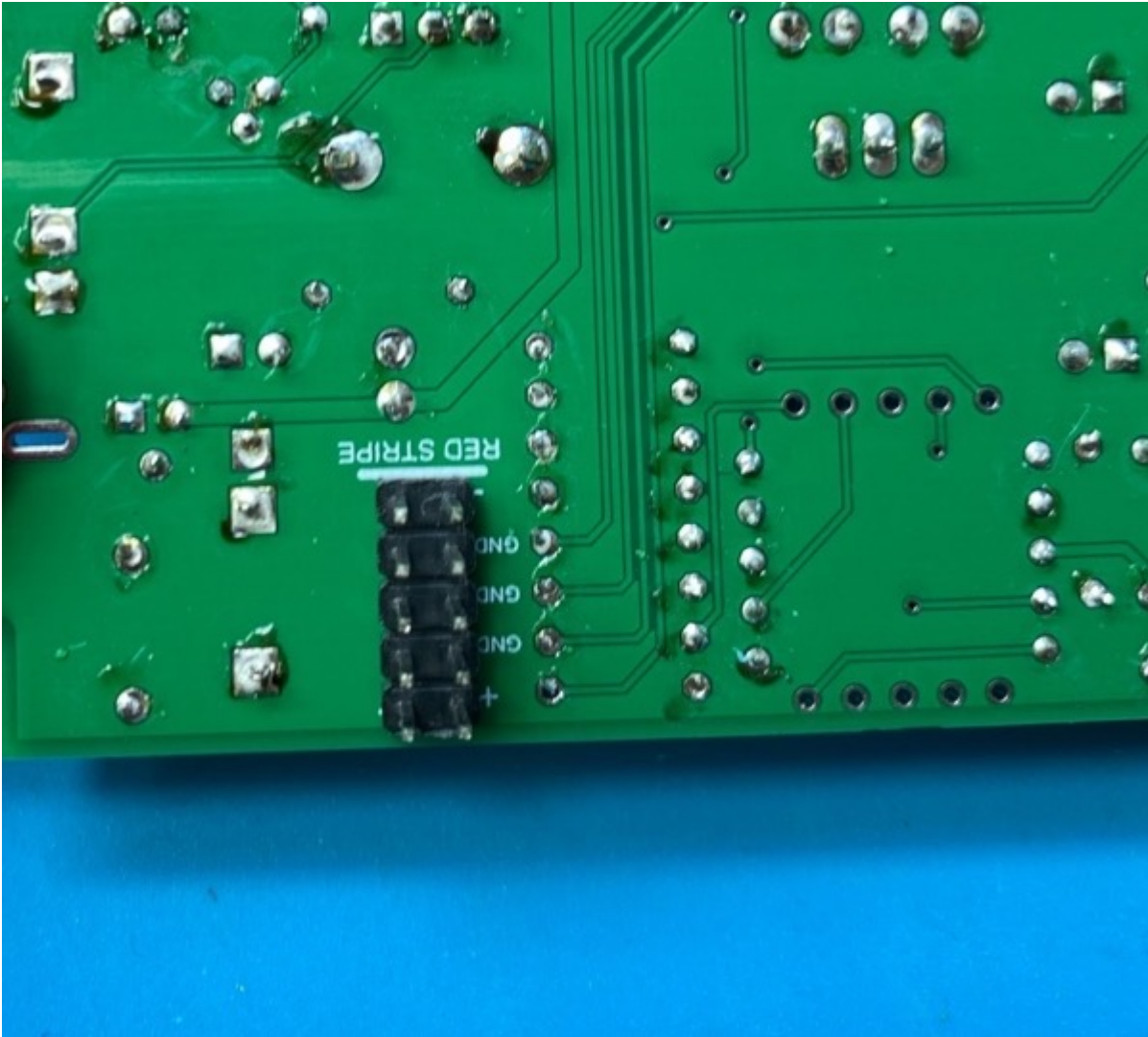

Grab the two switches.

You can just install the spacers if you want to rise the switch a bit up. They are not necessary on Eurorack and Bricky, and a bit tricky to keep in place.

It's best to check how the panel looks with or without the spacers BEFORE soldering the switches!

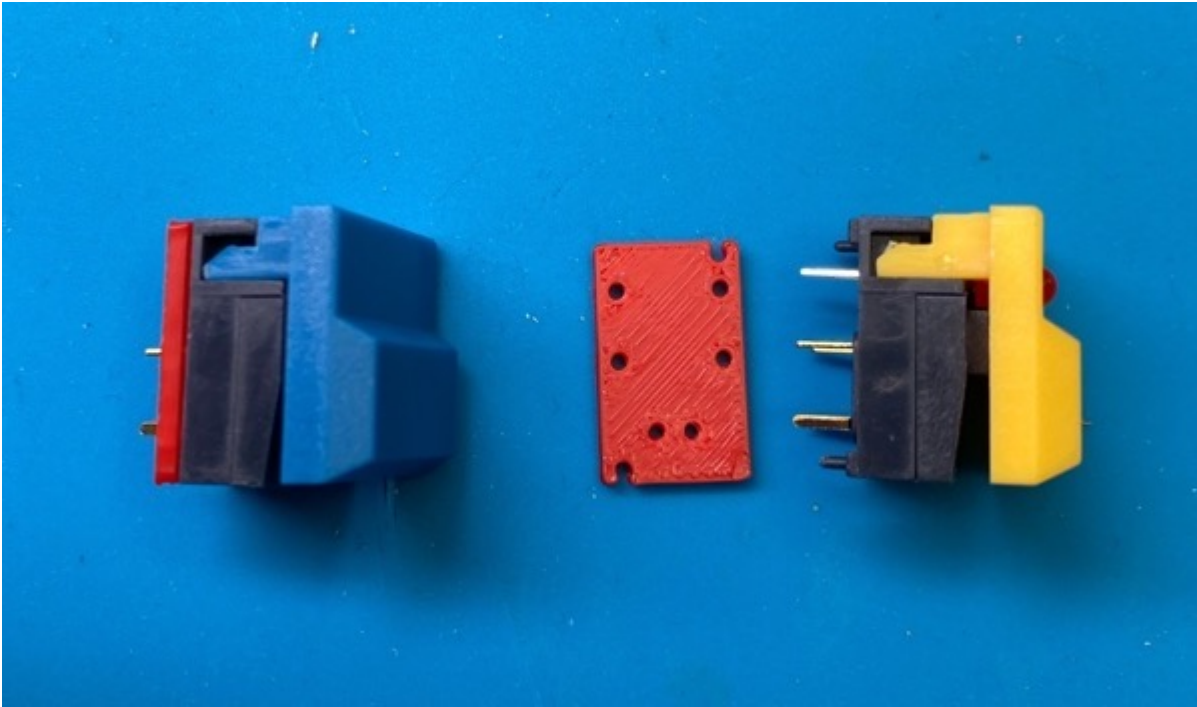

Install the switch in place !!□ the yellow on the left, the blue on the right

Note that the PCB is also designed for Eurorack; therefore, be gentle when inserting the switches into place and **make sure they are in their correct orientation!** Check the two following pictures.

Here is how to place the tactile switches on the Bricky version :



Here is how to place the tactile switches on the Eurorack version :

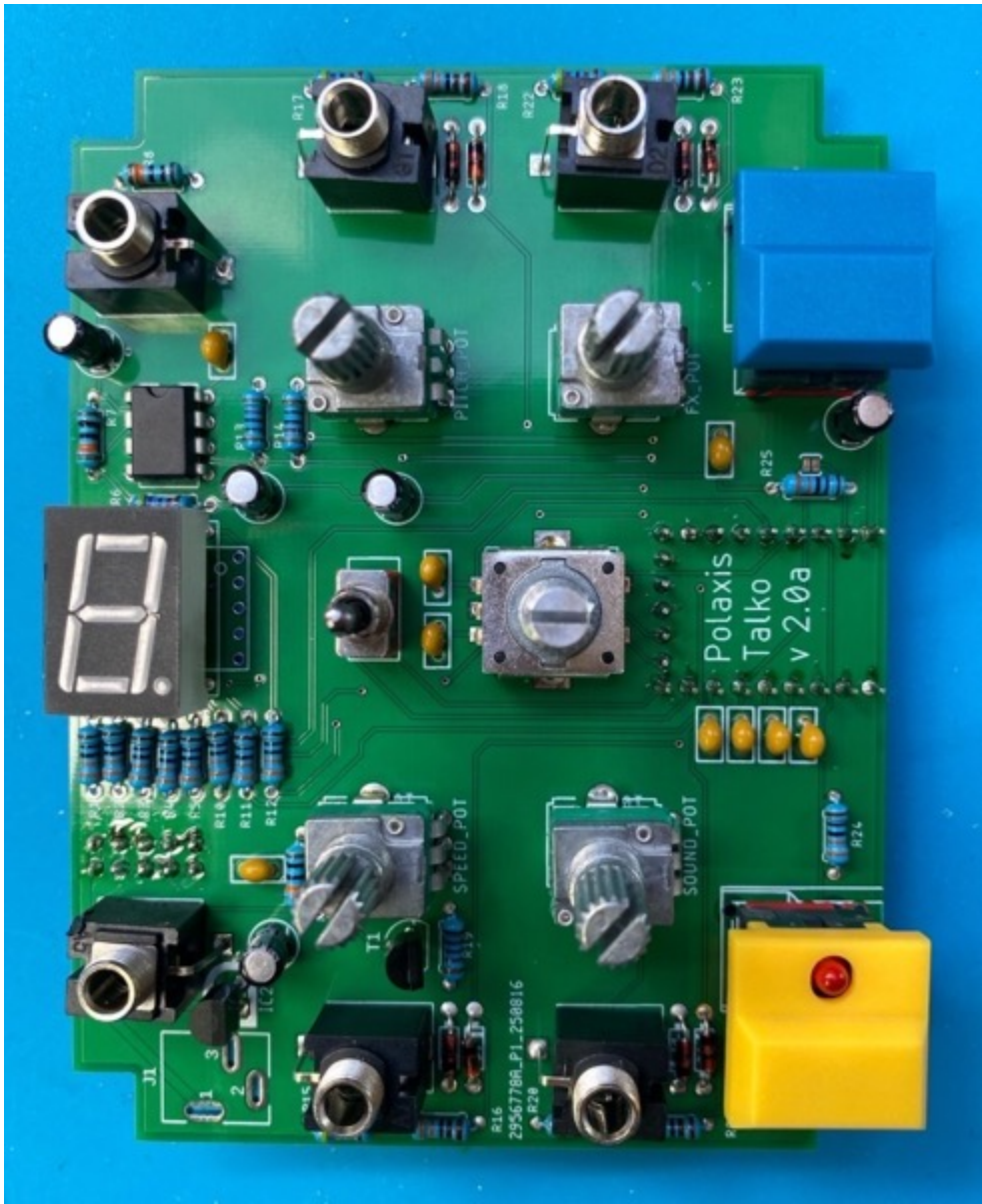

Place the panel back in position and use tape to secure the switches.



Eurorack version



You can now solder the switches.

Last step: add the nuts, knobs, and screws, and... tada! You are done.

Firmware

Now you are ready to flash the firmware :
Download it from here :

UF2

-

Talko 2 firmware

1 file(s) 282.50 KB

Login is required to access this page

[Login](#)

And follow these steps :

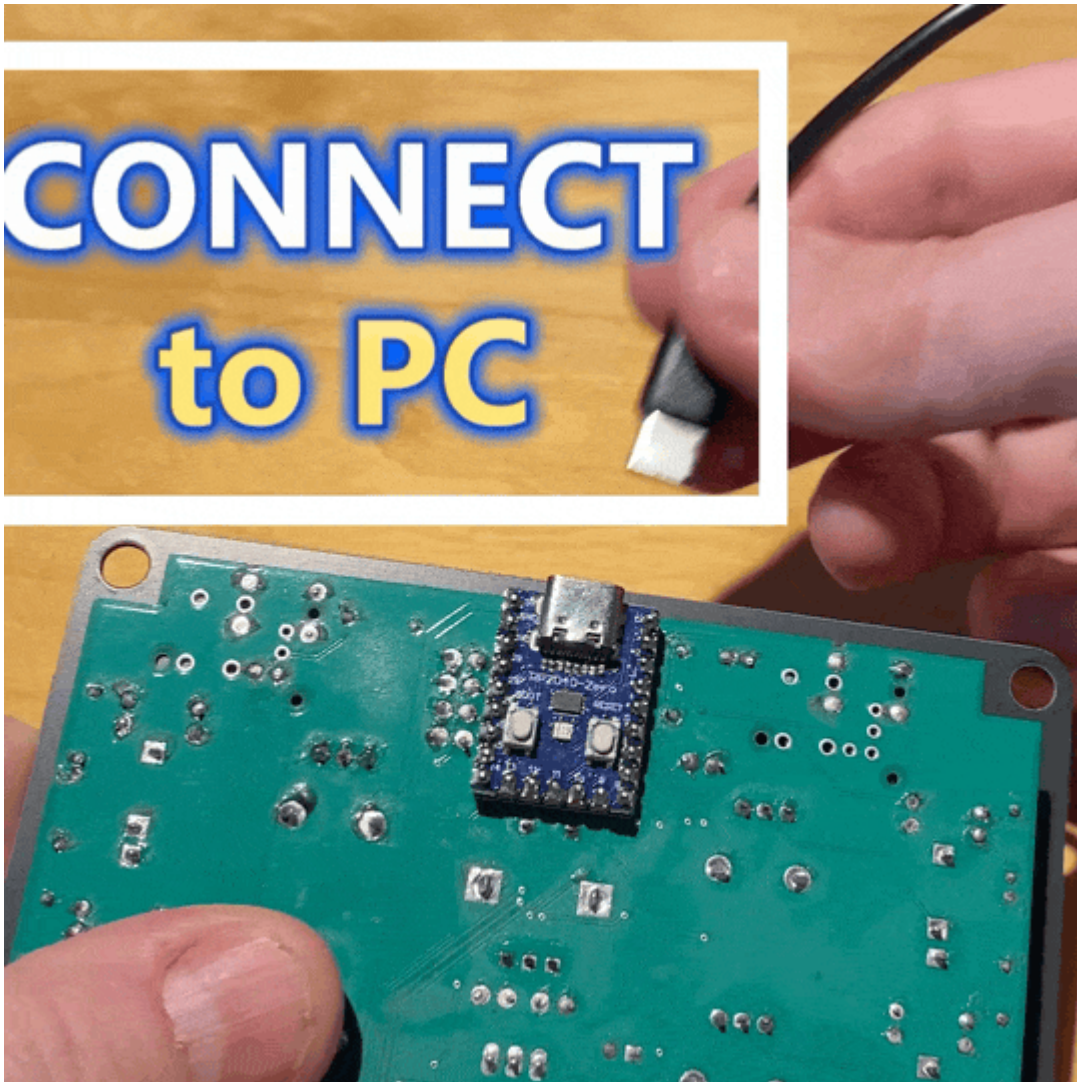

⚙️ Flashing the firmware

- Don't apply power yet
- Connect the Pico to the computer via USB-C (this will provide power but also data !)
- Hold BOOTSEL.
- While still holding BOOTSEL (don't let go!), press and release the RESET button

- Keep holding BOOTSEL button until the RPI-RP2 drive appears !
- Simply drag the UF2 to the drive !

Once the firmware is installed, you should see the Pico's LED blink to indicate the firmware version after each reset.



Talko troubleshooting guide